

HASSELBLAD
CFV 50c

USER MANUAL
v2



HASSELBLAD

Welcome to Hasselblad

CFV 50c



CONTENTS



INTRODUCTION	4	File Storage	20	Live View	33
Computer system requirements	5	Storage	21	Change Language	34
Warnings and restrictions	5	Folder	21	Temperature Warning	34
Firmware updates	5	Delete	21	Camera Connectivity	34
Workflow	7	Format	22	Flash/Strobe	39
Before you start	6	Settings	29	Appendix	42
Hasselblad Capture Files	7	Language	24	Cleaning	43
Capture destination	7	Sound	24	Language change	44
Phocus	8	Date & Time	24	Battery Life & Battery Warning	44
		Display	25	Technical Specifications	45
Getting Started	9	Custom Options	25	Equipment Care & Service	46
Buttons, Parts & Components	10	P Button	25		
Battery	11	Display Off	25		
Powering the CFV 50c	11	Power Off	26		
On/Off button	11	Mark Overexposure	26		
CF Cards	12	Image Orientation	26		
Navigating the Menu	13	Aspect ratio	26		
Overview of Menu	14	Show preview	27		
Menu	15	Camera	27		
Initial Settings	17	Service	27		
ISO setting	18	About	28		
White Balance Setting	18	Previews, Browsing & Live View	29		
Exposure Time	19	Preview Modes	30		
Quality	19	Browsing	31		
		Zooming	32		

About this manual

This manual describes how to work with the Hasselblad CFV 50c digital back only. Please refer to previously published manuals for details concerning older or discontinued Hasselblad equipment and firmware.

The manual explains specific practical aspects of operation and control, the menu system and suchlike. It is assumed that reasonable levels of general analogue and digital photographic knowledge as well as computer skills are already acquired, so these are not dealt with here.

The CFV 50c is the ultimate choice for those who want to extract the optimum from Hasselblad V series cameras and lenses when working digitally. This exceptional product uses the latest of everything in the world of digital backs regarding materials and firmware. Build quality is of course Hasselblad which is legendary.

CFV 50c



Insert photo: © Frank Meyl - Hasselblad Master 2012

Being a Hasselblad product means it is versatile and the CFV 50c is no exception as it easily converts a technical- or large format camera into a very convenient and very capable tool as well.

The key to this superb back is the fantastic CMOS sensor which opens up a new world of possibilities for V series owners. Teamed with Phocus, Hasselblad's proprietary image file editor, the CFV 50c offers:

ISO range is an amazing 100 - 6400 with remarkably little noise even at the most sensitive setting.

Longest shutter speed is over 34 minutes to provide a solution or to add a creative addition to many situations.

HNCS – Hasselblad Natural Color Solution – saves time and secures the job because skin tones or specific product tones are going to be rendered automatically, accurately and immediately without any fuss.

JPEG & RAW files can be produced simultaneously if you choose. The JPEG files are not only 1/4 resolution they are also HNC profiled so you can print straight from

a folder for amazing quality. RAWs are retained of course for your final masterpieces.

Digital Lens Correction, applied at the file editing stage, takes a discerning look at any colour aberration, distortion and light fall off however minor (which is inherent in any lens, anywhere) and resolves the situation automatically.

Capture rate is about as fast as you can crank the handle!

This is the product that some V series owners have been waiting for a long time in order to leave the analogue world behind and move on into top flight digital quality. For others it is the chance to have a foot in both the analogue and the digital worlds for the optimum of choice.

Versatility, with a capital 'V', is perhaps the word that sums up this product best - we know you are going to be satisfied.

■ INTRODUCTION

The captured image is temporarily stored internally on a CF card or externally via a FireWire connection onto a computer hard disk. When tethered to a computer you can remotely make captures using Phocus with some Hasselblad V system models/accessories (see later section in this manual and the Phocus user manual for further details).

As the CFV 50c is a purely electronic device, attention to power supply is vital. When working untethered it is therefore important to plan battery loading / battery replacement to ensure continued workflow. Likewise, image storage is limited and appropriate steps should also be taken when planning a shoot.

When attaching and removing the CFV 50c, pay particular attention to the image sensor area. The sensor itself is covered and protected by a glass IR filter but take great care when handling. If you need to clean the filter, see later section for specific details. When storing separated from the camera, always ensure you have replaced the protective cover. If you scratch or mark the filter in any way, it will show up on every shot. Replacements are expensive so treat the glass surface with at least as much care as you would a lens. The sensor itself is not accessible for any kind of cleaning or maintenance by a user. Do not attempt any such action as you will almost

certainly damage it irreparably. When storing separated from the camera, always ensure you use a protective cover.

As is the case with all electronic devices pay extra care when working in damp environments and avoid damp conditions for storage.

In keeping with Hasselblad's modular design philosophy, the CFV 50c is an independent component. It can be attached to a large format / view camera (see later section in this manual) for both tethered and untethered use.

With untethered use, the management of captures is handled by the CFV 50c. In tethered use, captures are handled and stored by the computer and can be visually checked in Phocus immediately.

Settings are made entering the CFV 50c menu using the buttons on the unit. When tethered, some settings are available in Phocus.

We hope you enjoy working with the CFV 50c. The results will prove you made the right choice.

■ COMPUTER SYSTEM REQUIREMENTS

Final image-storage and correction requires a certain minimum standard regarding computer capabilities. Large image files require a high-performance computer with plenty of memory, advanced graphics capabilities and a recent operating system. In most cases, you will want your computer to include a FireWire 800/400 connector, which will enable you to load images directly from the camera. To load images stored on the removable compact-flash card, you could instead use a compact-flash card reader, but we still recommend FireWire for maximum flexibility.

■ CONNECTING TO A COMPUTER

To connect to a computer, attach a FireWire cable from the FireWire port on a computer to the port on the side of the CFV 50c. Ensure the orientation of the plug is correct.

When you are connected to a computer, the following applies:

- *The CFV 50c will take power via the FireWire cable if it is available (not all computers can supply power, notably PC laptops). This will help conserve the battery power.*
- *When using a Thunderbolt to FireWire adapter ensure you select the correct setting (see p 27 in this manual: Settings > Service > Tethered power)*
- *The destination medium and location are controlled from Phocus.*

■ WARNINGS AND RESTRICTIONS

- If you want to power the CFV 50c from a PC laptop (as opposed to a Macintosh laptop), you must ensure that the FireWire port on the computer is capable of supplying power. Please note the following:
 - Most recent Macintosh computers are compatible, both desktops and laptops.
 - Most recent desktop PC computers are compatible.
 - Most laptop PC computers are *not* compatible (but can be modified in many cases).
- Keep the CFV 50c and computer equipment away from moisture wherever possible. If the CFV 50c becomes wet, disconnect from power and allow it to dry before attempting to operate again.
- Always take great care when you remove the CFV 50c for cleaning as the exposed CCD sensor protective filter is vulnerable to damage.
- Keep all cables connected to or from the CFV 50c and computer out of the way where they cannot be tripped over.

■ FIRMWARE UPDATES

If you have registered your CFV 50c you should automatically receive e-mail informing you of the latest developments. Otherwise you are advised to make regular checks regarding firmware updates.

When updating you should also study the accompanying 'Release Notes' or 'Read Me' files where you will find details about improvements, developments and changes.

■ USER MANUAL







This user manual is primarily designed for on-screen PDF reading to exploit search tools etc. However, there is a sufficiently wide left margin to allow one-sided print outs to fit an ISO standard ring binder if required.

Please note that the format is A4 to conform with the most common standard. Therefore if printing out to US Letter format or similar please ensure you select "Fit to Printable Area" in the page scaling dialogue.

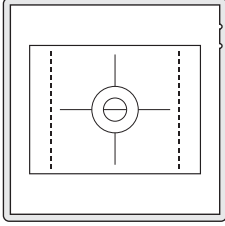
■ BEFORE YOU START

Please see below for items included with delivery. Please ensure that all the items noted on the accompanying packing information have been supplied and are correct. If anything is missing or seems faulty in any way then you should contact your Hasselblad dealer immediately.

Please keep purchase details and the warranty in a safe place. Become familiar with the various parts and components. Leave protective covers on as much as possible and avoid touching glass surfaces and inserting fingers into the camera body. Hasselblad cameras have a robust construction and are capable of withstanding fairly rough treatment but nevertheless are precision instruments and will serve you longer if treated with respect from the beginning.

			
Protective case	Protection cover 3054560	Focusing screen 3042264	CF-Flash card
			
Grey cards	E-wipes	CFV FireWire cable	Flash output sync cable 1006720
			
Exposure cable EL 1006721	Exposure cable 503 1006719	Flash input sync cable 1006722	Software and Adobe Lightroom DVD

The Hasselblad 555ELD, 500EL/ELM and 500/553 ELX models require a Battery Adapter (optional accessory 3054668) for untethered use. The Hasselblad ArcBody might also require the Battery Adapter at certain extreme settings. See page 37 in this manual.



**Optional battery adapter
3054668**

Register your CFV 50c for regular news about the latest developments, updates, news and tips!

– www.hasselblad.com –

HASSELBLAD CAPTURE FILES, PHOCUS & ADOBE/APPLE SOFTWARE WORKFLOWS



The CFV 50c captures files and stores them as Hasselblad RAW format files or Hasselblad RAW + JPEG formats simultaneously. Lossless compression is applied so the actual size of each capture can vary.

Hasselblad RAW files are initially stored in the 3FR format which is a proprietary Hasselblad format for the temporary storage of captures. A 3FR file contains the complete digitized raw image exactly as it was captured by the camera. 3FR information requires further computing power (typically by way of Phocus) to obtain complete development. If processed in Phocus, 3FR files become Hasselblad 3F files – denoted by each file now bearing the suffix “.fff”. If processed by other RAW processors, the 3FR files are not converted to 3F but can be exported directly to TIFF, PSD etc according to requirements.

However, when working tethered – which necessitates using Phocus – 3FR files are automatically processed and stored in the background on a computer appearing as 3F files on the hard disk ready for selective adjustment and export. 3FR files stored on a CF card can be processed to completion using:

- *Hasselblad Phocus (included)*
- *Adobe Camera Raw / Lightroom (included)*
- *Apple Aperture*

To sum up, capture files can be stored as 3FR files (on a CF card) for later processing in Phocus or other software, or they can be stored as 3F files (as a result of tethered shooting or 3FR files processed and imported to Phocus). In all cases if you keep the original 3FR/3F files, you will also retain the possibility of reprocessing them in the future in later versions of Phocus or other software to take advantage of eventual improvements and developments.

Note that using Phocus is the most comprehensive method. The Phocus and Adobe methods can produce almost identical results (V lens corrections, DAC, is not available with Adobe) regarding RAW conversion so it is a matter of personal choice regarding which method would best suit your preferred ways of working. Alternatively you can use Apple Aperture though you should take note that the benefits of DAC and HNCS etc, will be lost in this case.

Mixed formats

Phocus can also process most other capture formats, generic and proprietary. This means you can include other formats in your normal Phocus workflow if you choose. Or if you prefer, you can include Hasselblad files in Adobe / Apple workflows as stated above.

CAPTURE DESTINATION

The capture destination is the location to which new captures are saved and from which you can browse. Choice is normally automatic but a manual selection is also possible in some cases:

- *When untethered, a compact-flash card is automatically selected.*
- *When tethered, captures are automatically saved directly to the computer hard disk. See Phocus user manual about how to select or create a new storage folder.*

PHOCUS

Phocus is the capture processing and file management application aimed primarily at Hasselblad 3F file handling. Phocus Mobile offers remote viewing and control when shooting tethered while Phocus Quick offers a very rapid and simplified file processing capability.

Phocus allows the extraction of the most detailed files from the world's most advanced cameras to your desktop in a professional and efficient manner.

Phocus works the way that photographers work and provide serious photographers with a well thought out, and intuitive workflow, designed to provide maximum power and options with a minimum of effort. Phocus produces ground-breaking new levels of image quality and technical precision and when combined with the world's finest optics and image sensors the result is exactly what you would expect from Hasselblad – simply stunning image quality.

FEATURES IN PHOCUS

Ultimate Image Quality

- Hasselblad Natural Color Solution (HNCS)
- Sophisticated lens corrections for H and V system lenses

Specialized Tools

- Phocus Mobile *
- Live Video
- Scene calibration & reproduction tools
- Leading edge Moiré removal
- Highlight recovery, shadow fill, clarity and dust spot removal tools

plus:

- Easy-to-use interface
- Extensive customization options for individual workflow scenarios
- Import/Export of Image Adjustments, Keywords, Workflow settings etc.
- High quality printing
- Slide show
- RAW file support for more than 150 DSLR cameras
- License free software (unlimited installations - no registration issues)

Any File from Anywhere!

Phocus allows you to import your files, RAW or otherwise and work in the same powerful and intuitive processing environment, no matter where your files are coming from. This means that you can browse all kinds of RAW and non-RAW formats.

Phocus on a Mac supports RAW files from more than 150 cameras, including Canon, Nikon, Leica, Sony, Fuji, Olympus, and so on**, as well as the most common file formats such as TIFF, JPEG, DNG, and PNG, making it easier than ever to work as you see fit, not as your camera dictates.



Ultimate Image Quality

Phocus combines with Hasselblad Natural Color Solution (HNCS) and digital lens corrections to provide ultimate image quality in every image you create. With Phocus, the moiré that can occur on even extremely high-resolution images is effectively removed automatically and directly on the raw data, leaving image quality intact and saving hours of tedious post-production work.

Tethered shooting is also very smooth with Phocus Remote camera controls providing a number of remote functions, such as remote focusing, live view, aperture and exposure time controls, etc.

Phocus Mobile

Phocus Mobile is available for the iPhone®, iPad® and iPod Touch®. It enables you to connect wirelessly to a computer running Phocus and to remotely browse your high-resolution RAW, JPEG and TIFF images.

This provides a handy solution for working with clients in the studio, enabling each person to view images on an individual iOS device, rather than all gathering around a single computer.

Phocus Mobile also allows users to remotely operate and trigger a tethered camera, giving control of many parameters, all neatly presented in a virtual camera display. This feature is very convenient for remote control of the camera when it's located in a difficult-to-access position. Phocus Mobile is available for free download at the App Store.

Phocus Quick

Phocus Quick allows a preview of images from camera to screen at the touch of a button. Your original images (in RAW format) remain on the memory card and can be backed up automatically if you wish. Either way, you can view and review in Phocus Quick and still go back later and fine-tune your images. The perfect combination of ease of use and peace of mind! Phocus Mobile is available for free download from the Hasselblad website.

* Phocus Mobile is available for download on the App Store.

** Full list available at <http://www.apple.com/aperture/specs/raw.html>

GETTING STARTED



Photo: Bryn Griffiths © / Hasselblad Masters

BUTTONS, PARTS & COMPONENTS

1 MENU / (EXIT) button

Opens and closes the menu system. Also used for various other tasks (EXIT button, for example) as you issue commands navigating the menu system.

2 P button

Assignable button to access a specific function. Setting is made via Custom Options.

3 Navigation button

A four-way rocker button enabling you to browse images as well as navigate the menu system.

4 Zoom- in/-out (Selection) button

A dual function button for preview inspection and menu option selection. Zoom in to view close-ups of previews for focus checking. Zoom out to view several at once and finally to view and select folders and media. Also acts as the selection button for value setting.

5 Display button

Steps through the various viewing modes of the preview.

6 On / Off button

Turns the CFV on and off.

7 Ready-light

Indicates CFV 50c's condition. **GREEN** signifies a new capture is possible (steady or blinking). **ORANGE** signifies the unit is busy (writing to a CF card or sending data, for example) and so a new capture is not possible. **RED** signifies a problem (an explanatory message will be displayed).

8 CMOS and IR filter

The sensor is positioned behind a permanently mounted IR filter. Always be very careful not to touch or scratch the surface of the filter when it is exposed. Replace the protective cover whenever the CFV 50c is not mounted on a camera.

9 Databus connectors

For digital communication with certain camera models.

10 CF-card cover

Protective cover for CF card slot..

11 'Sensor plane' index

For physical focus measurement in critical close-up work.

12 FireWire port

For computer connection.

13 Flash sync and power connector ports

Ports for Flash sync, Winder CW and EL-Cameras as well as external power adapter. Protected behind a rubber cover.



■ ATTACHING AND REMOVING THE CFV 50C

When both attaching and removing the protective cover as well as attaching and removing the CFV 50c to the camera, slide the locking button **A**. Avoid trying to just 'snap' the CFV 50c or protective cover into place without using the button.



■ POWERING THE CFV 50C

The CFV 50c requires power either from the battery (7.2V Sony InfoLithium L type – NP-F550 for example) or from a computer via a FireWire cable.

To attach a battery:

1. Firstly, ensure the battery is fully charged (see user appropriate manual for battery and charger).
2. Position the battery as in the illustration.
3. Press the battery towards the camera **A**. This automatically depresses the battery retaining catch. Slide the battery into the final position **B** ensuring the contact prongs on the camera are inserted into the battery. The battery retaining catch will now return to the safety position.

To remove a battery:

1. Depress the battery retaining catch **C** and slide the battery over it **D**. It will then be freely removed.

FireWire connection:

1. Connect a FireWire cable between the FireWire port on the CFV 50c and the FireWire port on the computer. You do not need to attach a battery with a FireWire connection.

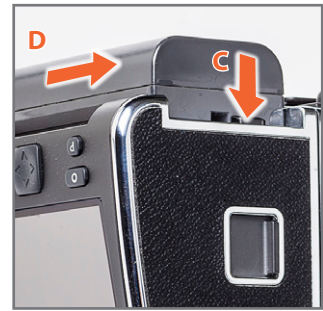
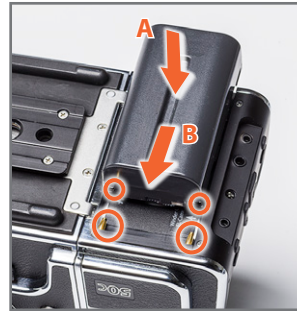

Note

The Hasselblad 555ELD, 500EL/ELM and 500/553 ELX models also require a Battery Adapter (optional accessory 3054668) for untethered use. The Hasselblad ArcBody might also require a Battery Adapter at certain extreme settings. See 'Camera Connectivity'.



■ ON / OFF BUTTON

With a fully charged battery fitted, keep the **ON/OFF** button until the LED is illuminated. A Hasselblad logo splash screen will appear on the display followed by an audible signal. This signifies that the CFV 50c has been activated.

The CFV 50c will enter standby mode after the preset time to save the battery. Keep the **ON/OFF** button depressed again to turn the CFV 50c off. An audible signal will be heard again to confirm this.

When using a FireWire connection you have to press the button as usual for activation but only if the battery remains attached. If the connection is FireWire only, active mode is instigated automatically. The splash screen appears but no audible signal is heard from the CFV 50c. There may be an audible signal generated by the computer, however. Removing the FireWire connection turns the CFV 50c off immediately, also without an audible signal from the CFV 50c.

Tip

If the situation allows, change the **Time Out and Power Down** settings to reduce battery consumption.

Tip

Save battery consumption by turning down the brightness and/or contrast of the display using the Items on the MENU > SETTINGS > USER INTERFACE > DISPLAY menu. You can also save battery consumption by changing the Display Off/Sleep/Power Off settings.

Note

Time & Date settings on the CFV 50c (which are included with your capture files and batch labels) are updated automatically through a FireWire/Phocus connection. These settings are retained for some weeks by a small rechargeable cell that is automatically recharged by the main battery or FireWire with regular use.

If problems occur, charge the cell by leaving the CFV 50c on for approximately 12 hours.

■ INSERTING A CF CARD

1. Open the CF card slot cover by inserting a thumb in the recess and then sliding it to the left.
2. Behind the cover, you will see a slot for the card (A) and a release button (B) below the slot.
3. Hold the compact-flash card so that the connector holes face into the slot and you can read the brand label when you are behind the camera. Gently press the card into the slot. If you encounter resistance, it might be because you are holding the card backwards or upside down.
4. If the card can be easily inserted nearly all the way into the back, then you are inserting it correctly. Press the card another couple of millimetres firmly into place.
5. Close the slot cover and slide it to the right to lock it.

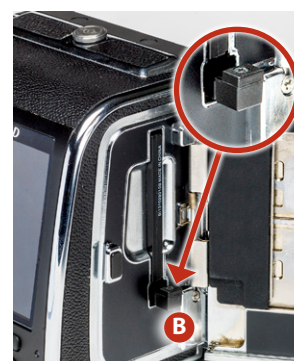

■ REMOVING A CF CARD

1. Open the CF card slot cover
2. Press the release button (B) a little way in and then release it so that it extends a little out from the slot.
3. Press the now extended release button all the way back into the unit again. Some force is required. As you do this, the card will be pushed out a few millimetres.
4. Grasp the card and pull it away from the unit.
5. Close the slot cover shut again.

■ CF CARD TIPS

1. All CF cards should be formatted in the CFV 50c before first-time use even if the CFV 50c is already able to read it. This will enable the CFV 50c to use the card more efficiently.
2. You can also use the 'Format' command for the purpose of deleting all images on a card. This is sometimes faster than using the delete function but it is not as flexible because all data from all batches will always be erased.
3. Be aware that formatting will erase all data contained on the target medium, so ensure you have backed up all required files beforehand.
4. Do not remove a CF card from the CFV 50c if the 'ready' light is blinking! All files on the card may become corrupted (and consequently lost) if you do so and new formatting may also be necessary.
5. Only UDMA/type 4/60MBs (or 400x) cards or better are recommended for CFV 50c use. See list in below.

■ RECOMMENDED CF CARDS

Lexar Professional Compact Flash	8	800x
Lexar Professional Compact Flash	16	1000x
SanDisk Extreme Compact Flash	8	60 MB/s
SanDisk Extreme Compact Flash	16	90 MB/s
UDMA 6 SanDisk	32	90 MB/s
UDMA 6 SanDisk	64	90 MB/s
UDMA 7 SanDisk	128	100 MB/s

Ensure you format all previously unused cards in the CFV 50c before use for optimum performance.

Do not remove a CF card from the CFV 50c if the 'ready' light is orange. All files on the card may become corrupted (and consequently lost) if you do so and new formatting may also be necessary.

NAVIGATING THE MENU

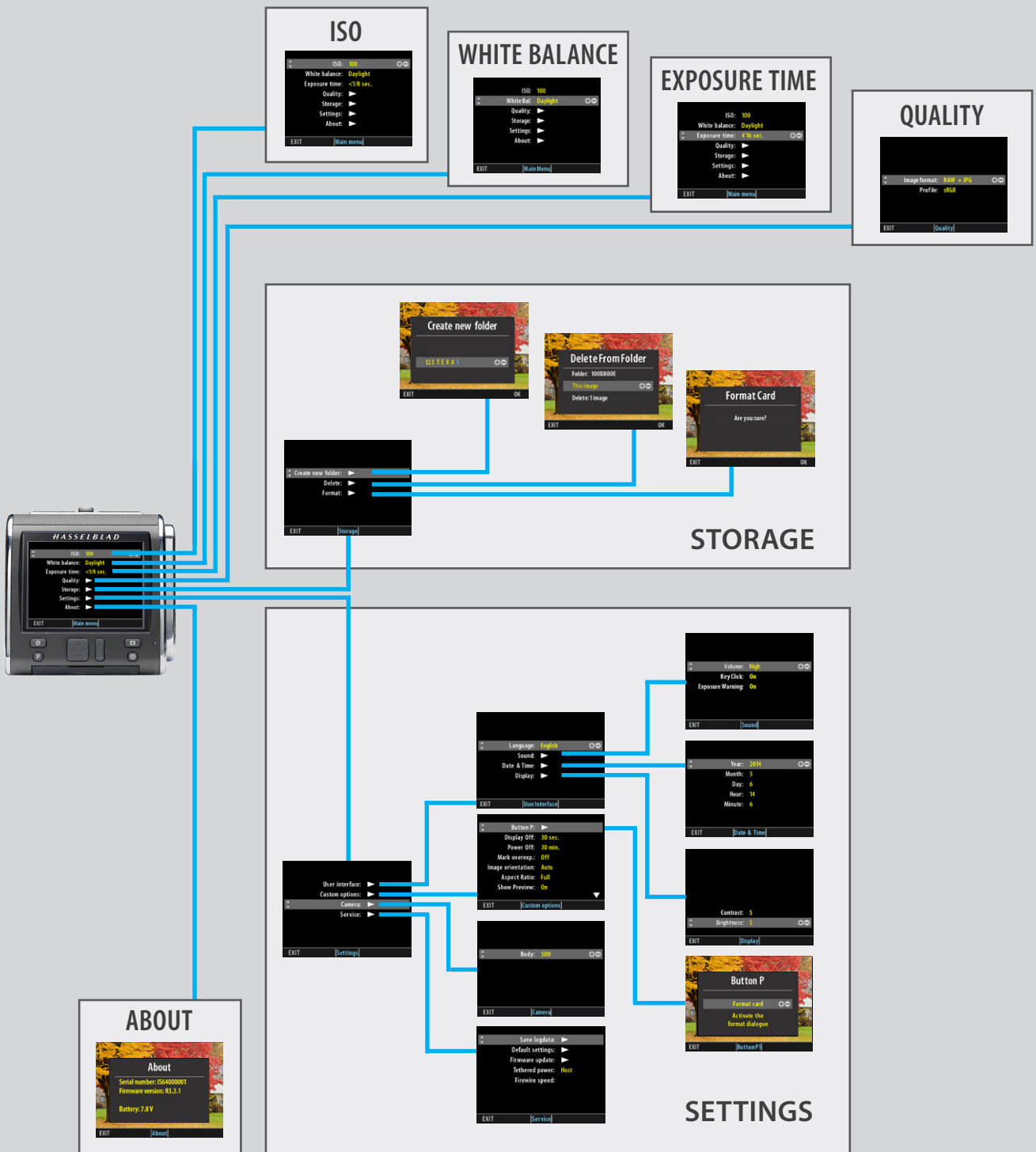

Photo: Bryn Griffiths © / Hasselblad Masters

BASIC OVERVIEW OF MENU & SCREENS

The menu is structured in a manner similar to very many digitally controlled personal devices and should be familiar to most. Once the menu is accessed, navigation, selection and confirmation are made by the various buttons beneath the display.

The first screen presents the main divisions: ISO, White balance and Quality – for rapid access while working – followed by Storage, Settings and About.



BASIC DESCRIPTION OF MENU ITEMS

By using the buttons on the control panel you can navigate down through the various levels in the menu. Below is an overview of the setting options available.

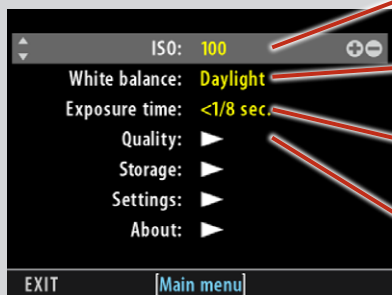

ISO
Sets the light sensitivity of the sensor.

White Balance
Sets the colour temperature to match the light source.

Exposure Time
Sets the appropriate setting to match the selected lens shutter speed/exposure time.

Quality
Allows option of RAW only or RAW + JPEG per capture. Also allows profile (sRGB /Adobe 1998).

STORAGE

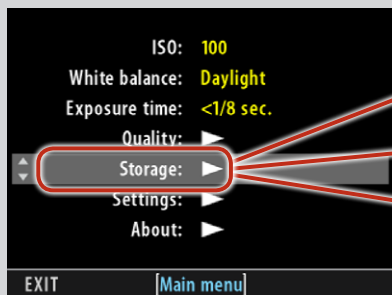

Create new folder
Allows extra file folders for better workflow.

Delete
For single or multiple deletion of images.

Format
Used to format CF cards for optimum use.

SETTINGS

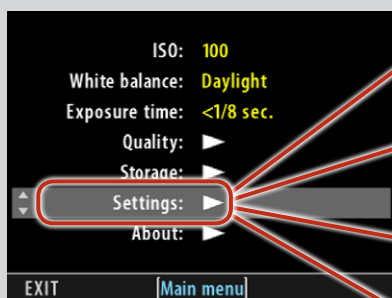

User interface
Sets menu language, sound, date & time and display.

Custom Options
Sets options regarding P Button, show preview, mark overexposure, etc.

Camera
Accesses the individual settings requirements for the various Hasselblad V system models as well as for view camera / large format use.

Service
Accesses save log data, default settings, firm-ware update, tethered power and firewire speed.



About
Provides serial number, firmware revision and focus calibration information.

OVERVIEW OF NAVIGATING MENU AND SETTINGS.

Navigating the menu and accessing the settings on the CFV 50c are achieved by pressing the appropriate buttons surrounding the display. Note that some of the buttons are modal and so have dual functions which is indicated by the designation that appears closest to that particular button when navigating. For example, the MENU button also acts as a SAVE or EXIT button according to dialogue requests. To take another example, the VIEW DISPLAY button will activate the spirit-level function but is not indicated accordingly because it requires a long press. These variations are all mentioned in the relevant sections.



In this example the Menu button acts as the Exit button and the Display button acts as the OK button according to the mode.

Here is an example of the necessary steps to take to make a setting change, in this case Sound. The actions are illustrated in full here to clearly describe the procedure. The procedures later on in this manual are described and illustrated in an abbreviated manner so it wise to study this full description first.

1

Press the **MENU** button to access the menu from the regular image display.

2

Press the up **▲** or down **▼** arrows on the **Navigation** button to access **Settings**. The highlight on the menu item indicates selection of that particular item.

3

Press **>** on the **Navigation** button) to access **Settings** – indicated by an arrow on the menu list – to navigate to the submenu screen.

4

Press the up **▲** or down **▼** arrows to highlight **User interface**. Press **>** on the **Navigation** button to access **Sound**.

5

Press the **Zoom** button – indicated by the **+** or **-** symbols on the menu list – to step through the available choices until the desired one is shown.

6

Press the **Exit** (Menu) button to confirm and save the choice as well as return to image view.

INITIAL SETTINGS

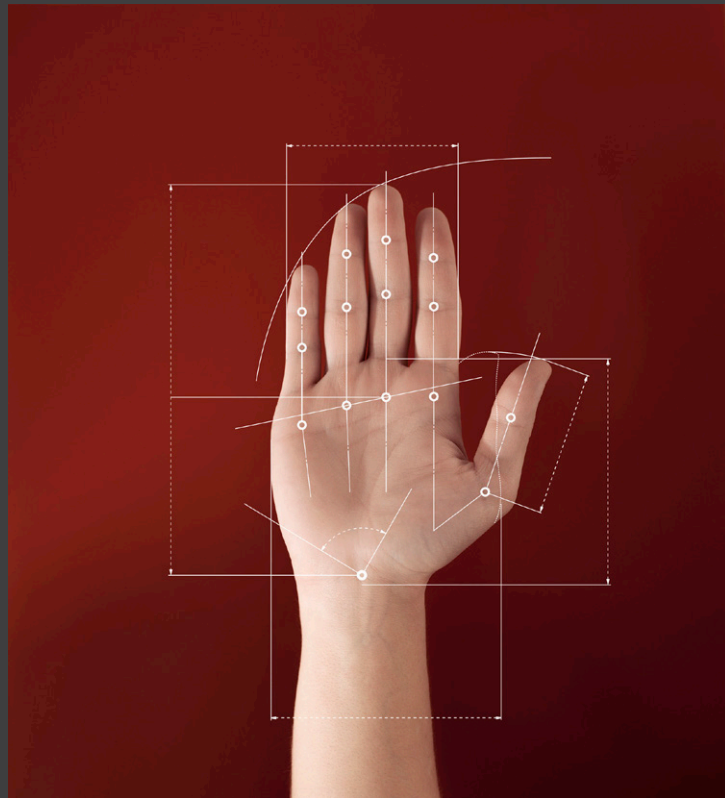
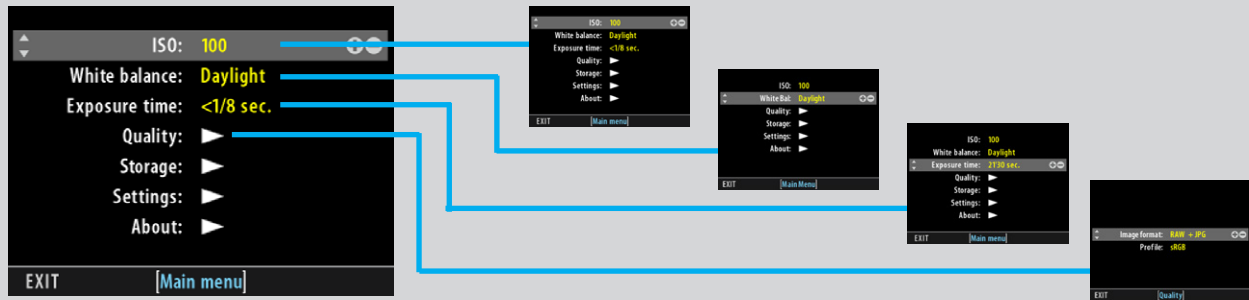

Photo: Paul Gisbrecht © / Hasselblad Masters

MENU – INITIAL SETTINGS



ISO SETTINGS

MENU > ISO

1. Press **MENU**.
2. Navigate to **ISO**.
3. Press the **ZOOM** button to step through the available settings.
4. Save the chosen selection by pressing **EXIT (MENU button)**.

ISO can also be set on the CFV 50c when tethered, via Phocus.



WHITE BALANCE SETTING – PRESETS:

MENU > WHITE BALANCE

There are six 'White Balance' presets plus two manual methods of white balance setting to choose from.

1. Press **MENU**.
2. Navigate to **White Balance**.
3. Use the **ZOOM** button to step through the available settings.
4. Save the chosen selection by pressing **EXIT (MENU button)**.

White balance can also be set on the CFV 50c when tethered, via Phocus.

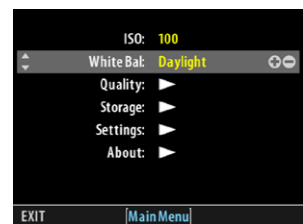

White Bal. Setting	Setting description
Daylight	For general outdoor use in direct sunlight.
Cloudy	For general outdoor use in cloudy weather.
Shade	For general outdoor use in shady locations out of direct sunlight.
Flash	For general indoor use when using a normal flash/strobe system.
Fluorescent	For use when using fluorescent lighting (strip lights).
Tungsten	For use when shooting indoors under standard tungsten/B lamps.
Manual	For a manual setting

Note

White Balance settings are technically not necessary for 3F/3FR files because raw format files contain all the information required for correction in Phocus and/or other software, regardless of the original color temperature of the light source or color temperature setting on the CFV 50c at the time of exposure.

However, if you intend to shoot RAW & JPEG or use Phocus / Phocus Quick for JPEG production and plan to deliver or print the JPEG files directly, then you should make a White Balance setting.

WHITE BALANCE SETTING – NUMERICAL VALUE SETTING:

MENU > WHITE BALANCE

Manual setting allows a specific numeral setting.

1. Press **MENU**.
2. Navigate to **White Balance**.
3. Use the **ZOOM** button to step through until you reach **Manual**.
4. Use the **Navigator** to access the dialogue.
5. Press the **ZOOM** button to select the desired numerical setting.
6. Save the chosen selection by pressing **EXIT (MENU button)**.

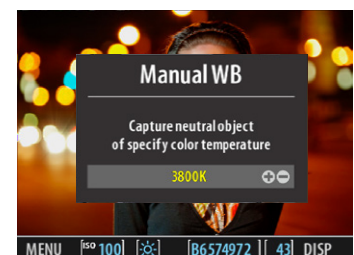

WHITE BALANCE SETTING BY USING A 'GREY CARD':

There are two ways to make manual white/grey balance settings using a 'Grey card' or 'Qp card' (supplied). If colour accuracy is not critical, you can use any neutrally coloured area or surface that you judge to be close to a mid-grey value (concrete, overcast sky, or even white paper, for example). It won't be perfect but just try to ensure that it is as neutral as possible in colour value.

- Make the first shot a grey card/Qp card close-up and then make the adjustment in Phocus for the session.
- Use the integral white balance from grey card function to make an in-camera setting for the session.

White balance settings are mirrored in Phocus when tethered.

MANUAL WHITE BALANCE 'GREY CARD' IN-CAMERA SETTING:

MENU > WHITE BALANCE > MANUAL

1. Press **MENU**.
2. Navigate to **White Balance**.
3. Navigate to **Manual** then press again the Navigation button again.
4. Position the central spot in the viewfinder over an area that you consider should be rendered as neutral in color in the image and make a test capture (ensure the exposure is approximately correct otherwise you will see a warning message). A small rectangle appears on the display marking that particular area.
5. Press the **MENU** button to exit the menu system and keep the setting. Calculations then take place automatically so that the following shots use the area chosen as the new 'white balance' standard. Using this method you can also read off the screen what the color temperature of the light source has been judged to be in degrees Kelvin.

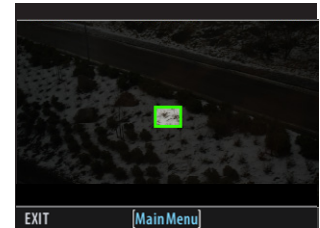

White Balance Shot screen appears after test capture to illustrate the area chosen for white balance calculation.

EXPOSURE TIME

MENU > EXPOSURE TIME

Exposure time is set in accordance with the already determined shutter setting. Increments from are 1/8 second or faster.

1. Press **MENU**.
2. Navigate to **EXPOSURE TIME**.
3. Press the **ZOOM** button to step through the settings.
4. Save the chosen selection by pressing **EXIT** (**MENU** button).

Exposure time can also be set on the CFV 50c when tethered, via Phocus.

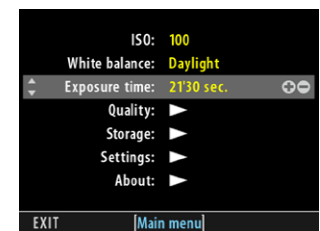

Tip

When changing large differences in exposure time it is more practical to use the Flash Sync cable method.

See Camera Connectivity in this manual.

QUALITY

MENU > QUALITY

Image format offers a choice between the creation of RAW only files or simultaneous RAW + JPEG files from each capture.

Profile offers a choice between an sRGB or an Adobe 1998 profile for JPEG captures.

IMAGE FORMAT SETTING:

1. Press **MENU**.
2. Navigate to **Quality**.
3. Navigate to **Image Format**.
4. Press the **ZOOM** button – to step through the available options.
5. Save the chosen selection by pressing **EXIT** (**MENU** button).

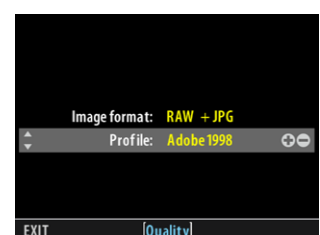
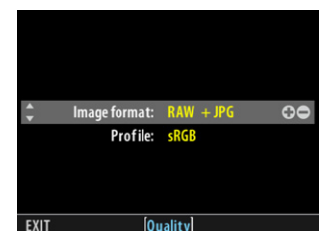

FILE STORAGE

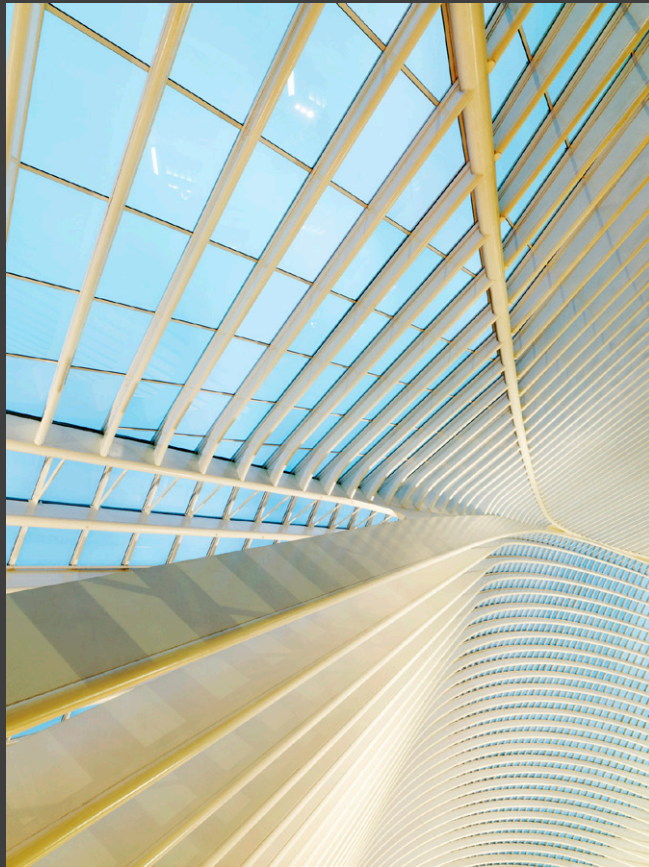
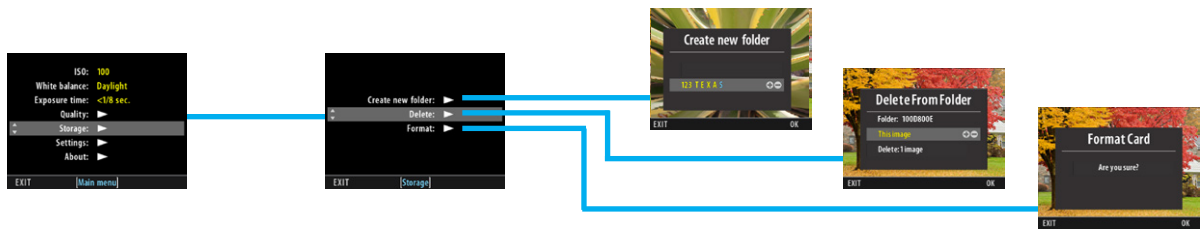

Photo: Martin Schubert © / Hasselblad Masters

STORAGE



Storage includes three entries: Create new folder, Delete and Format.

'CURRENT' FOLDER SELECTION

You can re-direct new captures to a selected folder for storage instead of the latest folder created.

1. Enter **Browse** mode
2. Zoom out (use the **ZOOM** out button \leftarrow) to reach the Folder View.
3. Navigate to the desired folder (use the **Navigator** and zoom in) and return to the Standard Preview.
4. In this way, the newly selected folder becomes the 'current' folder, so all new captures will now be stored there instead.

CREATE NEW FOLDER

MENU > STORAGE > CREATE NEW FOLDER

All new captures are automatically stored in the current folder until directed otherwise. A newly created folder automatically becomes the 'current' folder.

1. Press **MENU**.
2. Navigate to **STORAGE**.
3. Navigate to **CREATE NEW FOLDER** dialog.
4. The **CREATE NEW FOLDER** dialog allows folder naming. The first three-digits are fixed and are automatically incremented for each new folder. The following five characters can be assigned as follows:
Use the **Navigator** to select each character in turn. When selected (highlighted as blue) use the **ZOOM** button to select the desired character/digit.
5. Press **OK** (**Display** button) to save.



The last character has been selected and is colored blue to indicate that it can be changed. Pressing OK saves the new name and creates the new folder which now becomes the 'current' folder.

DELETE

MENU > STORAGE > DELETE

Delete allows you to make single or multiple deletes of captures.

1. Browse to image you want to delete
2. Press **MENU**.
3. Navigate to **Storage**.
4. Navigate to **Delete**.
5. Navigate to **Delete** dialogue.
6. Press the **ZOOM** button to step through options.
7. Press **OK** (**Display** button) to confirm.
 - You can choose to customise the P button for immediate access to 'Delete'.

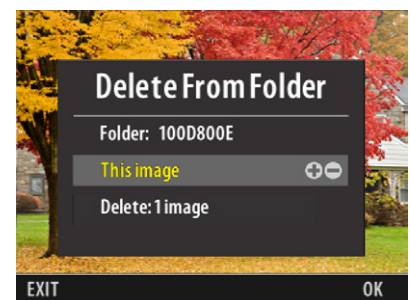

Note

You will always be asked to confirm each delete operation.

■ FORMAT

The camera is only able to read and write to storage media that have been formatted correctly. New cards sometimes have no formatting, or you might want to convert a card that is currently using a format that the camera cannot read. In either case, you must reformat the CF card.

MENU > STORAGE > FORMAT

1. Press **MENU**.
2. Navigate to **Storage**.
3. Navigate to **Format**.
4. Navigate to **Format** dialogue.
5. Confirm by pressing **OK** (**Display** button).
 - You can choose to customise the P button for immediate access to 'Format'.



SETTINGS



Photo: Bryn Griffiths © / Hasselblad Masters

SETTINGS

SETTINGS > USER INTERFACE

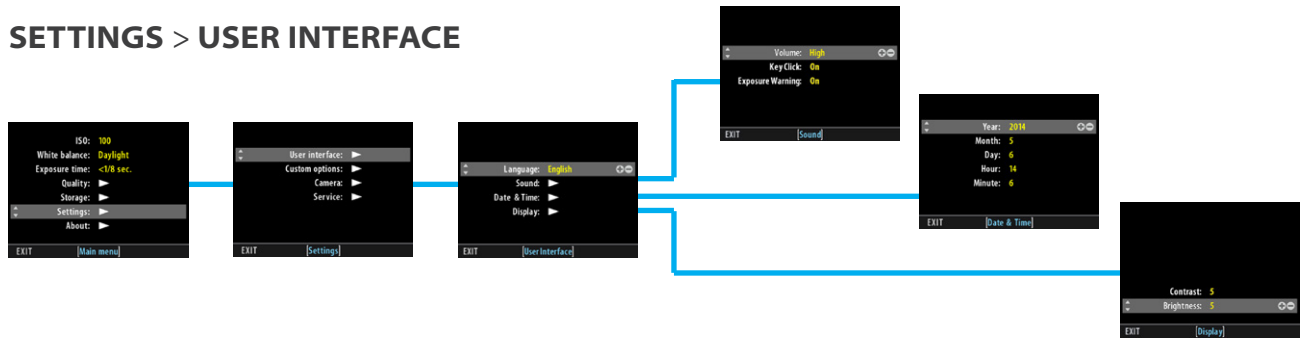

LANGUAGE

MENU > SETTINGS > USER INTERFACE > LANGUAGE

Language choice is retained but can be changed at any time. Choose between:

English, German, French, Italian, Spanish, Japanese, Chinese, Korean.

1. Press **MENU**.
2. Navigate to **Settings**.
4. Navigate to **User Interface**.
5. Navigate to **Language**.
6. Press the **ZOOM** button to step through options.
7. Save the chosen selection by pressing **EXIT (MENU)** button).

Tip

If the CFV 50c has been set to a language you don't understand (a rented back, for example), see section in *Appendix* for solution.

SOUND

MENU > SETTINGS > USER INTERFACE > SOUND

Volume level of all sounds and the option of 'key click' and 'Exposure warning' sounds can be selected:

1. Press **MENU**.
2. Navigate to **Settings**.
4. Navigate to **User Interface**.
5. Navigate to **Sound** the navigate to the options.
6. Press the **ZOOM** button to step through options.
7. Save the chosen selection by pressing **EXIT (MENU)** button).

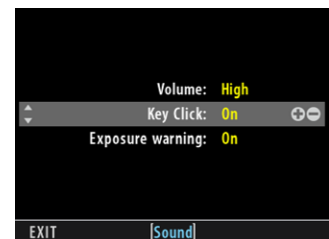

DATE & TIME

MENU > SETTINGS > USER INTERFACE > DATE & TIME

The CFV 50c has an internal clock that keeps track of the date and time. This information is used to mark each shot with the date and time at which it was taken. It is also used to label folders with the date on which each folder was created. (See note about keeping the internal battery charged to maintain *Date and Time* settings).

1. Press **MENU**.
2. Navigate to **Settings**.
3. Navigate to **User Interface**.
4. Navigate to **Date & Time**.
5. Navigate to required item to select it.
6. Press the **ZOOM** button to step through options.
7. Save the chosen selection by pressing **EXIT (MENU)** button).



Note

Time & Date settings on the CFV (which are included with your capture files and batch labels) are updated automatically through a FireWire/Phocus connection. These settings are retained for about two consecutive weeks by a small rechargeable cell that is automatically recharged by the main battery or FireWire with regular use.

If problems occur, charge the cell by leaving the CFV ON for approximately 12 hours.

■ DISPLAY

MENU > SETTINGS > USER INTERFACE > DISPLAY

This setting controls the level of **Contrast** and **Brightness** (both on a scale of **1-10**) on the display. Usually, you should leave this set to the default level of 5; however in some viewing environments and/or with some types of images you may wish to increase or decrease this value. A value of 10 provides maximum contrast; a value of 0 provides no contrast (a black screen) while a value of 10 provides maximum brightness; a value of 0 provides minimal brightness. Lower brightness values require less battery power.

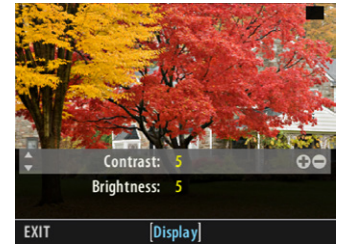

1. Press **MENU**.
2. Navigate to **Settings**.
3. Navigate to **User Interface**.
5. Navigate to **Display**.
6. Press the **ZOOM** button to step through options.
7. Save the chosen selection by pressing **EXIT (MENU button)**.

SETTINGS > CUSTOM OPTIONS

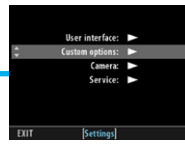

Custom Options allows the setting of various options, as listed here. The setting procedure is the same for these features:

1. Press **MENU**.
2. Navigate to **Settings**.
3. Navigate to **Custom Options**.
4. Navigate to required item.
5. Press the **ZOOM** button to step through options.
6. Save the chosen selection by pressing **EXIT (MENU button)**.



• P Button Function

MENU > SETTINGS > CUSTOM OPTIONS > P BUTTON

The P button is a customizable button to rapidly access a variety of functions.

OPTIONS: Delete image, Format card, Focus confirm, Live View, Browse mode, Mark over-exposure



• Display Off

MENU > SETTINGS > CUSTOM OPTIONS > DISPLAY OFF

Sets the amount of elapsed time before the display is turned off. See 'Power Modes' section in this manual for further details.

OPTIONS: 10 sec, 20 sec, 30 sec, 60 sec.

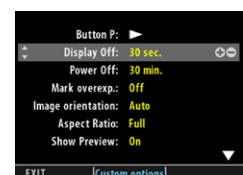

• Power Off:

MENU > SETTINGS > CUSTOM OPTIONS > POWER OFF

Sets the amount of elapsed time before the back turns itself off completely requiring a re-start.

OPTIONS: 30 min, 60 min, Never



• Mark overexposure

MENU > SETTINGS > CUSTOM OPTIONS > MARK OVER-EXP.:

Though a histogram shows you when some of your pixels are overexposed, it does not tell you which ones. In a shot with many bright areas, it can be hard to know whether the key parts of your image are just bright or completely overexposed. To help you find them, the H5D can provide an overexposure indicator, which shows precisely which areas of your shot are overexposed (i.e., pixels that are at maximum brightness, causing loss of detail). When enabled, the overexposure indicator flashes the overexposed pixels from black to white.

- You can choose to customise the P button for immediate access to 'Mark overexposure'.



Affected areas flash from black to white.

1. Press **MENU > SETTINGS > CUSTOM OPTIONS > MARK OVEREX.**
2. Select On or Off by pressing the **ZOOM (+ or -)** button.
3. Save the selection option by pressing **EXIT (Menu button)**.

• Image Orientation

MENU > SETTINGS > CUSTOM OPTIONS > IMAGE ORIENTATION

Sets the viewing orientation of captures when they appear in Phocus. Also avoids unintentional orientation changes when the camera is pointing straight up or down, for example. Settings can be locked at:

OPTIONS: Auto, Lock at 0 degrees, Lock at 90 degrees, Lock at 180 degrees and Lock at 270 degrees.

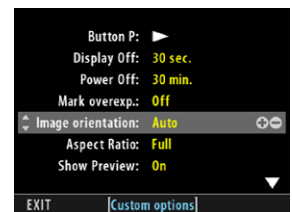
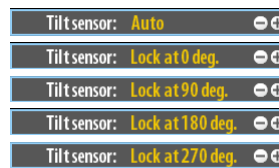

• Aspect Ratio

MENU > SETTINGS > CUSTOM OPTIONS > ASPECT RATIO
Aspect Ratio selects either Full or Square Crop of the files.

1. Press **MENU**.
2. Navigate to **Settings**
3. Navigate to **Custom Options**.
4. Navigate to **Aspect Ratio**.

5. Press the **ZOOM** button to select Full or Square Crop.
6. Save the chosen selection by pressing **EXIT (MENU button)**.

OPTIONS: Full, Square Crop.



• Show Preview

MENU > SETTINGS > CUSTOM OPTIONS > SHOW PREVIEW

Selects whether a preview appears after every exposure or not.

1. Press **MENU**.
2. Navigate to **Settings**
3. Navigate to **Custom Options**.
4. Navigate to **Show Preview**.
4. Press the **ZOOM** button to select On or Off.

5. Save the chosen selection by pressing **EXIT (MENU button)**.

OPTIONS: On, Off.

- You can choose to customise the P button for immediate access to 'Focus check'. This will adjust the preview to 100%.



• Animation

MENU > SETTINGS > CUSTOM OPTIONS > ANIMATION

Animation selects the behaviour of previews on the display when browsing and zooming.

1. Press **MENU**.
2. Navigate to **Settings**.
3. Navigate to **Custom Options**.
4. Navigate to **Animation**.

5. Press the **ZOOM** button to select.
6. Save the chosen selection by pressing **EXIT** (**MENU** button).

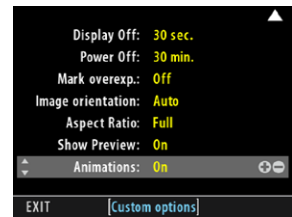

SETTINGS > CAMERA

MENU > SETTINGS > CAMERA

Selects the particular camera in use to ensure the correct exposure synchronisation. See 'Camera Connectivity' chapter for complete information.

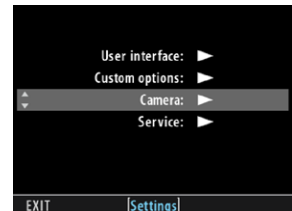

SETTINGS > SERVICE



■ SERVICE

MENU > SETTINGS > SERVICE

SaveLogdata saves a log file on the CF card.

Default Settings resets all settings back to factory settings. See the Appendix in this manual for a detailed list of the default settings.

Firmware update: Download the latest firmware update for the sensor unit from the Hasselblad website. Unzip the file first and then transfer the ".cim" file to a CF card. Insert the card in the camera and navigate to "Firmware update". The sensor unit will then automatically update.

Tethered power offers options when using a Thunderbolt to FireWire adapter, for example, on a MacBook Pro. This particular configuration does not supply enough power to the camera from the computer so in this case the 'Battery' option should be selected. Select 'Host' for all other configurations.

Firewire speed displays the setting for the current transfer rate.

1. Press **MENU**.
2. Navigate to **Settings**.
3. Navigate to **Service**.
4. Navigate to required item.
5. Press the **ZOOM** button to step through options.
6. Save the chosen selection by pressing **EXIT** (**MENU** button).

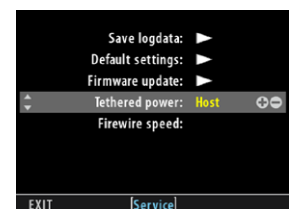

Select this option when using a Thunderbolt to FireWire adapter.

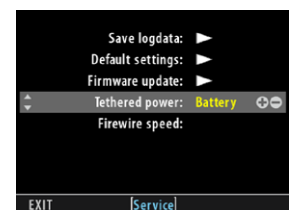

Select this option when using other configurations than a Thunderbolt to FireWire adapter.

ABOUT

MENU > ABOUT

The About box displays which firmware version is present so you can see if you have the latest (which can be downloaded from the Hasselblad website). The serial number is also displayed in case Hasselblad Support need to know it for any eventual problem solving.

1. Press **MENU**.
2. Navigate to **About**.



PREVIEWS, BROWSING & LIVE VIEW



Photo: Dmitry Ageev © / Hasselblad Masters

PREVIEW MODES

Use the **Display** button to cycle through the available preview modes which are:

- **Standard preview:**

Shows a preview image surrounded by a display of a few important settings. Note that the information covers some of the image. Go to Full-screen mode to see whole image.

- **Histogram:**

Shows a preview image overlaid with a histogram.

- **Full-screen preview:**

Shows the preview only, with no frame or settings information.

Two additional screens also available, accessible from the Histogram preview by pressing the up and down arrows on the navigation button.

- **Combined Histogram:**

Shows a preview image overlaid with a histogram displaying the three components: red blue and green.

- **Histogram and full details:**

Shows a preview image overlaid with both a histogram and camera-setting details.

Tip

Note that the display mode can also be changed when the camera is tethered to a computer.

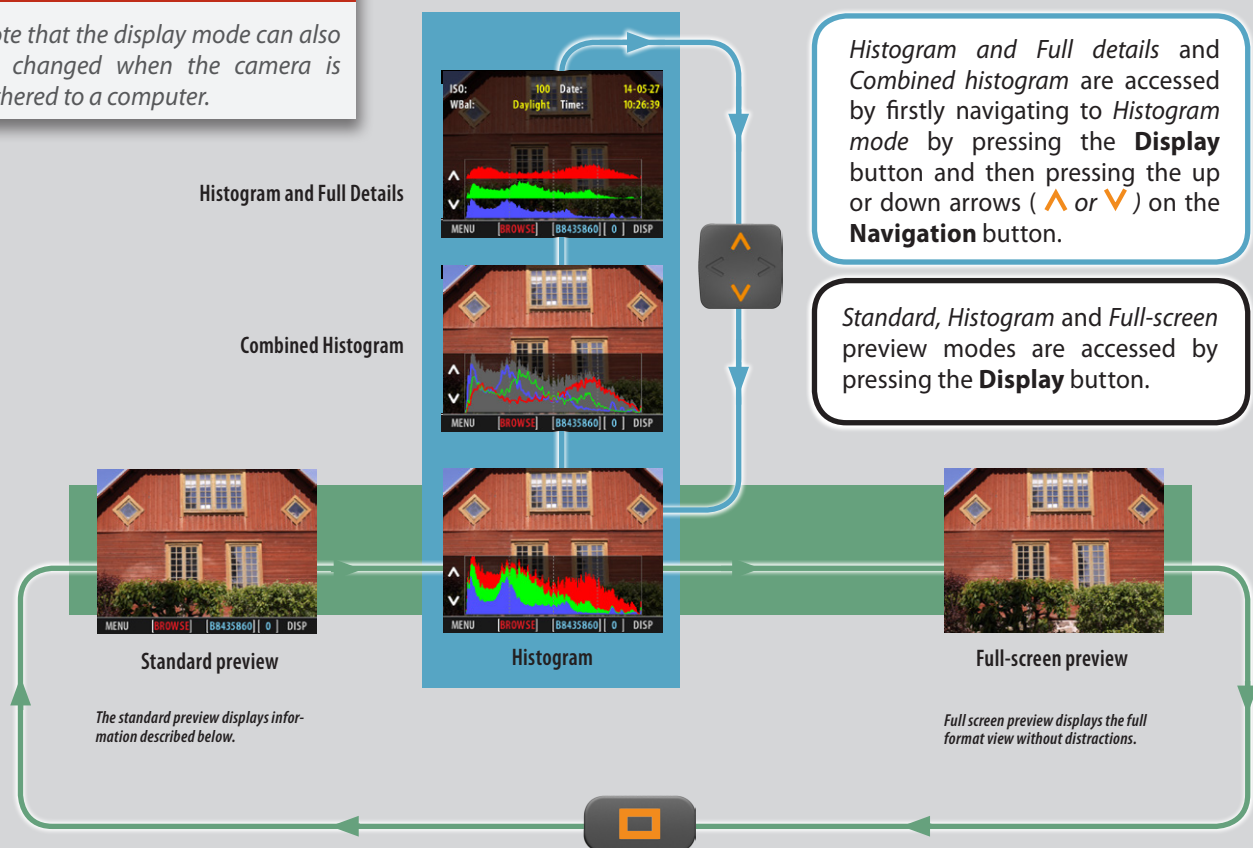

STANDARD PREVIEW

The Standard Preview display is the one shown when you first turn on the camera and is probably the view you will use most often.

It displays a preview of your most recent capture and basic information about the settings.

This preview also enables you to navigate the menu system. See *Simple description of menu items* for details.

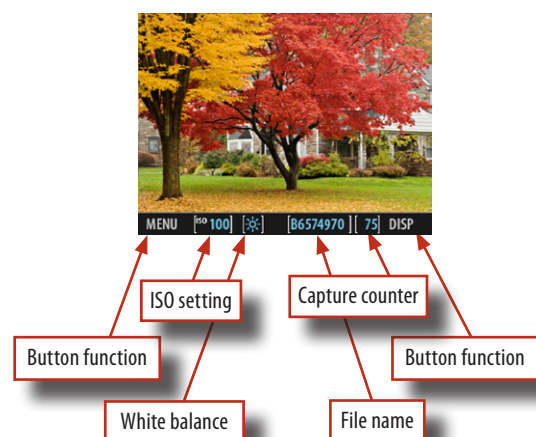

HISTOGRAM TYPES

There are three types of histogram representation available: *Histogram and Full details*, *Combined histogram* and *Histogram mode*.

Histogram and Full details

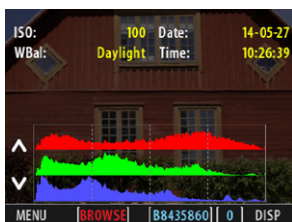

In Histogram and Full details mode, you can read a list of camera settings, plus see the histogram and, in the background, a darkened preview of the image. The setting details are stored with the capture file, so you can also refer to them in Phocus and other applications.

Combined Histogram

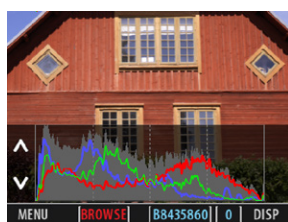

In Combined Histogram mode, the RGB channels are represented to show individual distribution against a luminosity histogram.

Histogram mode

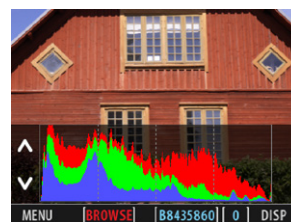

In Histogram mode, the individual RGB channels are represented to show a comparative display.

HISTOGRAM MODE – EXPOSURE LEVEL

The histogram provides a graph that indicates the total number of pixels at each brightness level, with brightnesses going from black on the left to white on the right. It is a valuable tool for evaluating captures. A well-exposed shot usually has a full range of levels, while under- and overexposed shots tend to show levels concentrated at the left or right part of the scale, respectively. The histogram is only an indicator that should be interpreted – there are several situations in which a 'bad' histogram will match an exposure that could be perfect for the intended effect (and vice-versa). Look at the histogram examples and the explanations below:

EVEN EXPOSURE

A histogram display that is spread across the full range indicates a likely good exposure. There may still be a few pixels at the extremes, indicating a few spectral highlights and saturated shadows, but this is often normal in a good exposure.

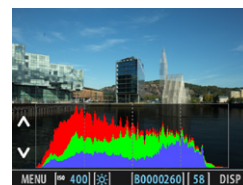

Even exposure

UNDEREXPOSURE

A histogram display that is concentrated on the left with few pixels elsewhere indicates a likely underexposure. Many details will be lost in the shadows.

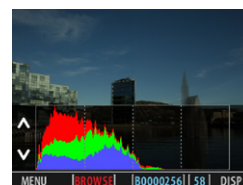

Underexposure

OVEREXPOSURE

A histogram display that is concentrated on the right with few pixels elsewhere indicates a likely overexposure. Many details will be lost in the highlights.

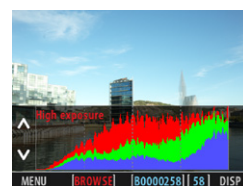

Overexposure

BROWSING

In **Browse** mode use the left or right arrows on the navigator button) to browse captures in a folder. Zoom out to Folder View if you want to select another folder to browse.

You can also browse when at a specific histogram setting where the graphs and information remain reflecting the new images.

- You can customise the smooth scrolling on or off in the Custom Options menu (Animations)



■ ZOOMING IN AND OUT

There are four views in **Browse** mode. Zoom in by using the *Zoom in (+)* / *out (-)* button.

Zoomed View is reached by zooming in from the Standard View. When zoomed in, you can select the area of interest by using the navigation button. A smaller inserted overview of the capture at 100% displays the position of the enlarged area with a blue frame. While zoomed in, navigate the blue frame (*with the navigator button*) to view other areas of interest for checking.

Standard Preview displays the full frame partially covered by the information bar at the bottom.

9-Thumbnail View displays an overview of your work so far and helps to find specific shots. Selection of specific images, highlighted by a blue frame, is made by the navigation button.

Folder view displays the list of folders saved. The highlighted folder is the current folder and contains the images you were browsing. Navigate to another folder and then zoom in to reveal its contents if desired.

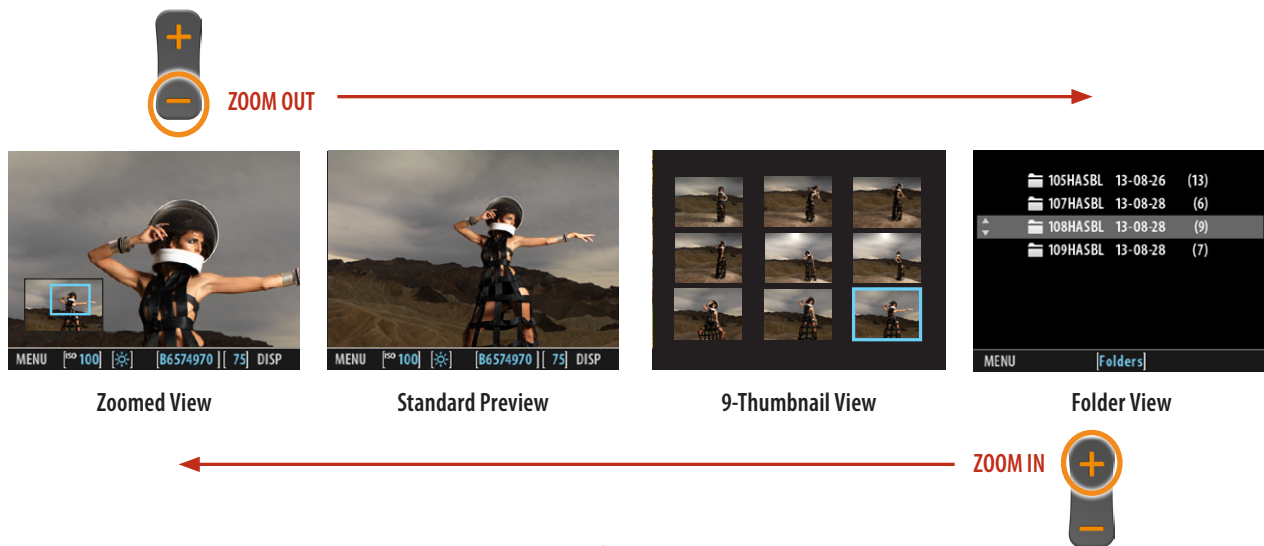

- You can customise the smooth zooming on or off in the Custom Options menu (Animations)

■ LIVE VIEW

Live View

This feature is useful for accurate focusing, composition, checking depth of field etc. It is activated by the **P** button.

1. Firstly, program either the **P** button to 'Live View'. Tip: for a short-cut to program the **P** Button, press '**MENU**' and next the **P** Button.
2. Set the camera to '**B mode**' and attach a lockable cable release. Note: 500 C/M and older have a lever that can keep the shutter release depressed.
3. Activate the '**B mode**'
4. Press the chosen **P** button. The display will now show a live image.
5. The CFV has an autoexposure function in Live View, but you can also use the aperture to change exposure level. Note: the lens must be stopped down.
6. Turn off Live View by pressing the same **P** button again and deactivate the '**B mode**'.

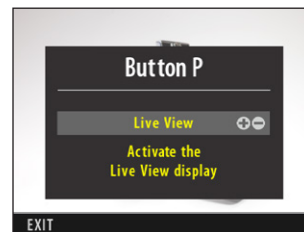

ZOOMING IN LIVE VIEW

1. Press '+' on the **Zoom Button**.



2. A cursor appears to select the chosen area for magnification.



3. Move the cursor by the **Navigation Button** to target the particular area required.



4. When the cursor is located correctly, press '+' on the **Zoom Button** again. The display now presents an image at 100% magnification which can be scrolled using the **Navigation Button**.



Before focusing



After focusing

5. Press '-' on the **Zoom Button** to return to full screen view.



Tip

Be aware when working untethered that Live View makes greater demands on battery consumption than normal operation.

CAMERA CONNECTIVITY



Photo: Bara Prasilova © / Hasselblad Masters

Connectivity diagram

This diagram illustrates the situation regarding V system cameras and the connection requirements according to model. All cables illustrated here are supplied.



CFV 50c digital back

Cable free operation

	500 C/CM 501 C/CM 503 CX/CXi/CW	
	SWC/SWC/M 903 SWC 905 SWC	<p>Battery Adapter (3054668) required for portable use. Optional accessory.</p> <p>Some limitations regarding image quality apply in some instances. See user manual for details.</p>
	Modified 202FA/203 FE / 205 TCC / 205 FCC With F type lenses and CF type lenses at F-mode setting	
	555 ELD 500 EL/ELM 500/553 ELX	<p>Battery Adapter (3054668) required for portable use. Optional accessory.</p>

Phocus remote control

(NOTE: only these cameras/combinations can be controlled from Phocus)

	503 CW + Winder CW	<p>Exposure cable 503 CW required for Phocus control of 503CW + Winder CW.</p>
	500 EL/ELM 500/553 ELX	<p>Exposure Cable EL required for Phocus control of EL/ELM and ELX use.</p> <p>Battery Adapter (3054668) required for portable use. Optional accessory.</p>
	555 ELD	<p>Battery Adapter (3054668) required for portable use. Optional accessory.</p>

Flash input cable always required

	2000 FC / FCM 2003 FCW 201 F / 203 FE 205 TCC / FCC	With C type lenses only (C-mode setting)
	ArcBody ¹⁾	May require a Battery Adapter (3054668) at certain extreme settings. Optional accessory.
	FlexBody	
	Any view camera with Hasselblad V System adapter ¹⁾	

¹⁾Note: Shift settings are not recommended on cameras with wide angle lenses and a short lens to image plane distance. E.g. the ArcBody.

SETTINGS > CAMERA

■ CFV 50C AND HASSELBLAD V SERIES CAMERAS

The various models in the Hasselblad V series have various capture sequence requirements depending on the situation. These can involve just a setting or a combination of setting and cable attachment. For example a 503CW only needs a setting but additionally needs a cable if a Winder CW is fitted and exposure via Phocus is desired.

Eight Hasselblad V models are listed plus the option of view/large format camera attachment. See chart in this chapter for an overview and the separated descriptions of the various Hasselblad V models below.

MENU > SETTINGS > CAMERA

1. Press **MENU**.
2. Navigate to **Settings**
3. Navigate to **Camera**
4. Navigate to required item
5. Press the **ZOOM** button to step through the options
6. Save the chosen selection by pressing **EXIT (MENU)** button).

The exposure time set on the CFV 50c sets the maximum length of exposure. The default setting is 1/8 sec and this is the setting that can be kept for all exposures from 1/8 sec through 1/2000 sec. However, this setting should be changed in accordance with the time required if it exceeds 1/8 sec.

If you prefer, you can connect the 'Flash sync input cable' between the lens PC socket and the CFV 50c which allows you to retain the default setting of 1/8 second while still being able to use exposure times longer than 1/8 second. This method also allows the use of the B setting. However, see special note *CFV 50c with all camera models* on following page concerning long exposures.

Model setting variations

Look in the list below for the camera model you are using and make the appropriate settings change. *Do not forget to change the setting if you change camera model!*

Note

Capture Sequence in Phocus functions in the same manner as an interval timer. It applies only to a motor or winder driven camera model and Pinhole mode.

Initial delay: Controls the amount of time required to elapse before the first exposure.

Delay: Controls the amount of time required between each exposure.

Count: Controls the total number of exposures required.

See Phocus user manual for further details.

Winder CW

For use with 503 CW models:

- Make a **Winder CW** setting.
- If you want to control the camera from Phocus, connect the 'Exposure cable 503' between the CFV 50c and the Winder CW as in the illustration.
- Do not use the winder at rapid sequence setting.



Hasselblad 503CW plus winder CW

ELD

For use with ELD models:

- Make an **ELD** setting.
- A **B** setting exposure can be made by choosing the 'Bulb' in the 'Exposure Time' setting.
- Only the single shot function (A or AS mode camera settings) should be set on the camera. Rapid sequence shots are not possible.
- Use a **Battery Adapter** (optional accessory 3054668) to provide the necessary extension beyond the motor housing of the EL models for battery attachment. It is attached to the CFV 50c in the same manner as a battery, and the battery itself is then attached to the adapter as in the illustration.



All Hasselblad EL models

ELX

For use with 500EL/ELM and 500/553ELX models:

- Make an **ELX** setting.
- The **Exposure Cable EL** (supplied) should be connected.
- Rapid sequence shots are not possible.
- Use a **Battery Adapter** (optional accessory 3054668) to provide the necessary extension beyond the motor housing of the EL models for battery attachment. It is attached to the CFV 50c in the same manner as a battery, and the battery itself is then attached to the adapter as in the illustration.

Exposure Cable EL

All Hasselblad EL models except ELD

Pinhole

For use with lenses/cameras with no shutter. Intended primarily for use in a studio environment where complete darkness can be achieved and exposures made accordingly, for 'light painting' etc. In this mode the CFV 50c uses the exposure time (as well as other required stages in a capture sequence) set in the Capture Sequence dialog. The CFV 50c can be triggered from Phocus (see later section for full description of Capture Sequence settings procedure).

Flash sync

For use with un-modified 200 series models (together with C-lenses in C-mode), an ArcBody, a FlexBody or view cameras fitted with a Hasselblad adapter.

- Make a **Flash sync** setting.
- A **Flash sync input cable** should be used.
- All exposures times, including the B setting, function correctly without having to alter the "Exposure Time" setting.
- Do not use a winder at rapid sequence setting.

SWC

For use with the 903 SWC and 905 SWC models (not recommended for critical use).

- Make an **SWC** setting.

*PLEASE NOTE: Due to the mechanical design of the SWC, pressing the exposure release button too slowly may cause a faulty capture with a magenta cast. Either press the button much more distinctly or alternatively change the setting from **SWC** to **Flash sync** and use the Flash input sync cable to connect the lens to the CFV 50c.*

200

For use with modified 202, 203 and 205 models together with F-lenses / CF-lenses in F-mode. (Only these three models can be modified for cable-free compatibility with the CFV 50c. Please contact your Hasselblad dealer for further information)

- Make a **200** setting.
- A **Flash sync input cable** should not be used.
- All exposures times, including the B setting, function correctly without having to alter the "Exposure Time" setting.
- Do not use a winder at rapid sequence setting.

500

For use with 500C/CM, 501C/CM and 503 CX/CXi/CW models.

- Make a **500** setting.

View / Large Format cameras

For optimum use, the CFV 50c can also be used with view cameras (with the appropriate Hasselblad H adapter and cables). The exposure time set on the unit sets the maximum length of exposure. The default setting is 1/8 sec and this is the setting that can be kept for all exposures from 1/8 sec through 1/2000sec. However, this setting should be changed in accordance with the time required if it exceeds 1/8 sec. Times of over 12 minutes can be set.

If you prefer, you can connect the 'Flash sync input cable' between the lens PC socket and the unit which allows you to retain the default setting of 1/8 second while still being able to use exposure times longer than 1/8 second. This method also allows the use of the B setting.

MENU > SETTINGS > CAMERA

1. Press **MENU**.
2. Navigate to **Settings**
3. Navigate to **Camera**
4. Navigate to 'Flash sync'
5. Save the chosen selection by pressing **EXIT (MENU button)**.

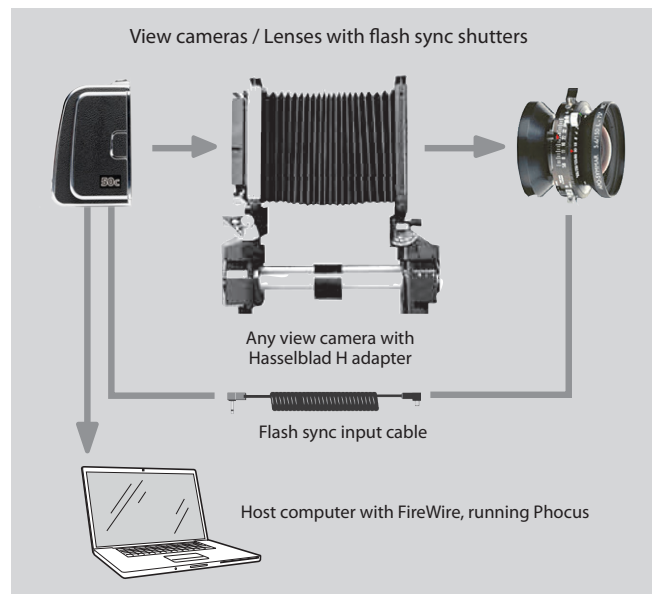

Note: Shift settings are not recommended on cameras with wide angle lenses and a short lens to image plane distance.

Note

Although the 903SWC and 905SWC models work in conjunction with a CFV 50c, the combination is not recommended for critical work in certain instances. It is difficult to predict all photographic situations so it is advisable to read the following and make a judgement followed by checking the focus on the preview to see if it matches your expectations.

The Biogon 38 lens was designed for film use where the unusually close proximity of the lens to the film plane was of no consequence. However, digital sensors and their protective filters make very different demands on the angle and travelling distances of the peripheral rays exiting the rear lens element. Gradual unsharpness consequently occurs towards the edges of the frame, particularly noticeable with flat subjects (typically copying situations, 90° shots against building façades, etc) though these effects will be naturally less obvious with more three-dimensional subjects. Slight green and magenta casts are also caused, though these can be removed digitally in Phocus.

Note

CFV 50c with ALL CAMERA MODELS

Long exposure times (1/8 s and longer in this case) can occasionally produce capture anomalies such as very strong colour casts, posterization etc. This, however, is not caused by a fault in the camera or back but by the sensor being exposed to light before or after the main exposure time selected on the CFV 50c back.

To avoid this situation you can:

- a) Increase the setting on the back by approximately 10-20% while retaining the determined shutter setting. For example, a 5 sec exposure time would require a 6 sec setting on the back or a 25 sec exposure would require a ca. 30 sec setting, etc.

or, for optimum ease of use as well as security, the recommendation is:

- b) Use the supplied **Flash input sync cable**. By connecting this cable from the flash terminal on the lens to the **Flash sync IN** terminal on the back, you can bypass the need for any specific long exposure time settings on the back.

Note

The Hasselblad 555ELD, 500EL/ELM and 500/553 ELX models require a **Battery Adapter** (optional accessory 3054668) for untethered use. The Hasselblad ArcBody might also require a Battery Adapter at certain extreme settings.

The adapter unit consists of two connected battery mounting plates. It is attached to the CFV 50c in the same manner as a battery allowing the extra mounting plate to be accessible for attaching the battery itself.



A Hasselblad ELD model illustrating the adapter and battery in use.

FLASH / STROBE



Photo: Joseph Goh © / Hasselblad Masters

TETHERED / studio / computer

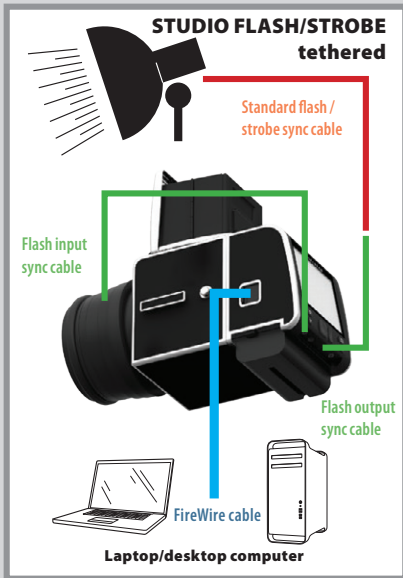

ALL CAMERA MODELS

Flash / strobe connection for CFV 50c digital backs.

Please note the different ways of connecting the various camera body / CFV 50c / flash /computer combinations.

In particular, notice the importance of the correct connections when using a FireWire link directly to a desktop computer in combination with studio flash /strobe.

The Flash input sync cable, Flash output sync cable and FireWire cable are supplied.

Pay particular attention when using studio flash/strobe units in conjunction with a desktop computer. Ensure you use the correct configuration to guard against both personal injury and damage to equipment.

TETHERED / portable / laptop

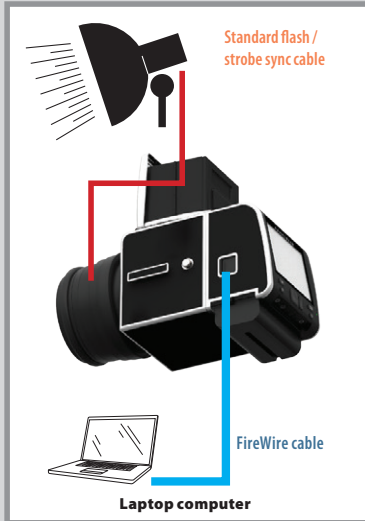

500 C/CM, 501 C/CM, 503 CX/CXi/CW, 555 ELD, 500 EL/ELM, 500/553 ELX, SWC / SWC/M, 903 SWC and 905 SWC.

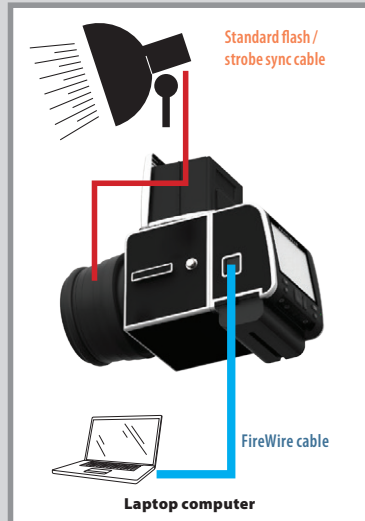

Modified 202FA/203 FE / 205 TCC / 205 FCC with F type lenses and CF type lenses at F-mode setting.

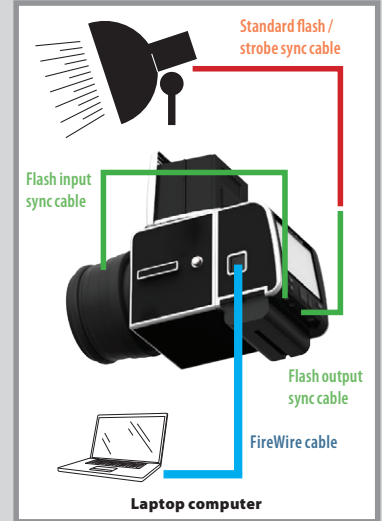

Modified and unmodified 2000 FC / FCM, 2003 FCW, 201 F / 203 FE, 205 TCC / FCC with C type lenses (C-mode setting). FlexBody. Any view camera with Hasselblad V System adapter.

UNTETHERED / portable / CF card

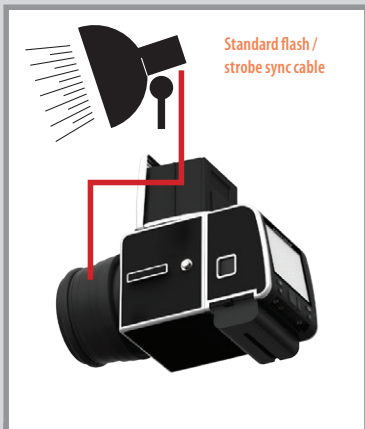

500 C/CM, 501 C/CM, 503 CX/CXi/CW, 555 ELD, 500 EL/ELM, 500/553 ELX, SWC / SWC/M, 903 SWC and 905 SWC.

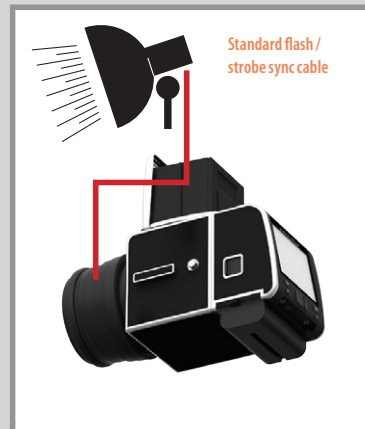

Modified 202FA/203 FE / 205 TCC / 205 FCC with F type lenses and CF type lenses at F-mode setting.

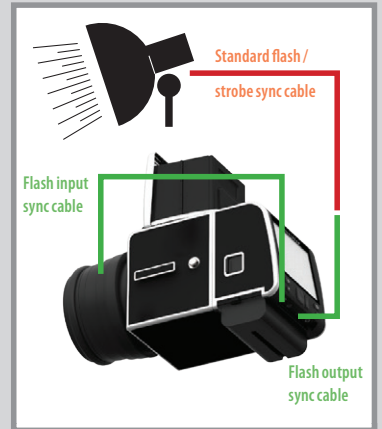

Modified and unmodified 2000 FC / FCM, 2003 FCW, 201 F / 203 FE, 205 TCC / FCC with C type lenses (C-mode setting). FlexBody. Any view camera with Hasselblad V System adapter.

■ FLASH / STROBE

Various configurations of cables are needed to match the requirements of various CFV 50c / Hasselblad body combinations. In addition, some modification might be required for certain camera bodies. Neither of these points however are directly related to CFV 50c use but rather to general flash use. See the chart on the following page for details.

503CWD or 503CW+CFV 50c combination

A 503CWD or 503CW+CFV 50c combination offers TTL flash control with some slight adjustments. As the reflective characteristics of the digital sensor are different to film surface characteristics (for which the TTL function was originally designed), this function has to be slightly 'tricked' to perform correctly. Proceed as follows:

Move the film speed selector on the camera so that it becomes approximately $1\frac{2}{3}$ f/stop higher than the ISO setting on the CFV 50c. Therefore, for example, when the CFV 50c is set at 50 ISO, the 'film speed setting' on the camera should read 160 ISO, and so on. Testing for the most suitable compensation that suits you is recommended.

■ STUDIO FLASH/STROBE UNITS WHEN TETHERED TO A DESKTOP COMPUTER

If the 503CWD/CFV 50c is tethered to a computer that is connected to a regular electricity supply system as well as a studio flash/strobe unit that is also connected to a regular electricity supply system/generator system, then make the following connections instead. For your own safety and to protect the electronics in the CFV 50c, please ensure you do this correctly.

- a) Connect the **flash input sync cable** from the sync contact (PC connector) on the lens to the **flash sync IN terminal** on the CFV 50c.
- b) Connect the **flash output sync cable** from the **flash sync OUT terminal** on the CFV 50c to a regular flash/strobe sync cable that is connected to the unit.

■ CFV 50C AND HASSELBLAD 200 SERIES CAMERAS

Connection to 200 series cameras depends on whether they are modified or not (contact your local Hasselblad Service Center about modification). TTL is also possible if the flash/strobe unit allows. See the appropriate camera manual for further details.

Please note the difference below – unmodified cameras can only use C lenses (C/CF/CFi etc) at the C-mode setting whereas modified cameras can use C and F-type lenses.

■ CAMERAS (WITH PORTABLE FLASH/STROBE UNITS) WITH C TYPE LENSES:

- a) Connect the **flash input sync cable** from the sync contact (PC connector) on the lens to the **flash sync IN terminal** on the CFV 50c.
- b) Connect the **flash output sync cable** from the **flash sync OUT terminal** on the CFV 50c to a regular flash sync cable that is connected to the unit.
- c) Use the C-mode setting.
- d) Shutter speeds faster than 1/90 sec allowed.

■ MODIFIED CAMERAS (WITH PORTABLE FLASH/STROBE UNITS) WITH F AND CF TYPE LENSES:

- a) Connect the **standard PC / flash / strobe sync cable** from the sync contact (PC connector) on the camera body to the unit.
- b) Use F type or CF type lenses at the F-mode setting.
- c) Use a shutter speed no faster than 1/90 sec.

APPENDIX

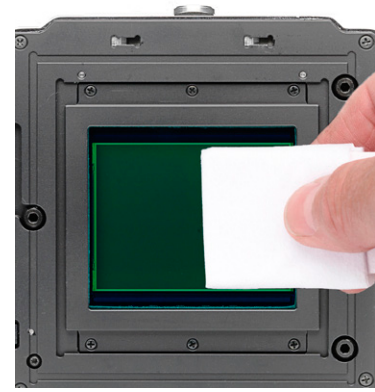

Photo: Hengki Koentjoro © / Hasselblad Masters

■ CLEANING THE SENSOR FILTER

If you see dark or colored spots or lines in your images, then you may need to clean the outer surface of the CFV 50c's infrared (IR) filter. In most cases, the careful use of compressed air will be adequate though if you use canned compressed air, read the instructions very carefully before use to avoid spraying impurities or even ice on the filter! Sometimes, however, small particles will get stuck to the surface of the IR filter, requiring for a more thorough cleaning, involving either fluid or wipes.

1. If compressed air did not remove all the problems on the filter, then use an E-wipe.
2. Tear at the notch to break seal. Remove E-wipe from its packaging and fold the tissue to match the width of the IR filter.
3. Apply firm pressure using two or three fingers at the edge of the wipe to ensure an even, firm contact with filter surface. Wipe the surface in one unbroken motion.
4. Finally check if the IR filter has been properly cleaned either by visual inspection or by mounting the CFV 50c to a camera and making a test capture. If further cleaning is needed, repeat cleaning procedure.



Note

If you still see spots on your shots after you have cleaned the outside of the infrared filter, then you may have dust either on the inside of the IR filter or on the sensor itself. However, never attempt to remove the glass filter – you will probably ruin the sensor if you do so!

If dust manages to get between the IR filter and sensor, it can only be removed at the Hasselblad factory. Contact your Hasselblad dealer or Hasselblad Service Center for assistance.

Note

Do not use same side of the e-wipe twice as you might re-apply any particles removed in the first pass.

■ BATTERY LIFE & BATTERY WARNING

Battery life is dependent on a number of variable factors and therefore cannot be exactly predicted. If the camera is left in the active state for long periods, for example, then the battery will naturally become exhausted much faster. Adjusting *Display Off* to activate sooner will help.

A low camera battery state is indicated by a symbol on the display and in addition, an audible signal sounds and obvious measures should be taken.



Low battery warning

■ TEMPERATURE WARNING

Many rapidly taken captures make heavy demands on the processor in the CFV 50c which in turn produces heat. This, particularly in combination with high ambient temperature, can result in noise in the image files. To prevent this, the CFV 50c displays a warning icon when the temperature rises.

At ca. 60° C a warning dialogue appears signifying that the CFV 50c is temporarily shutting down to allow it to cool.



■ CHANGING UNKNOWN LANGUAGE SETTING

MENU > SETTINGS > USER INTERFACE > LANGUAGE

If the CFV 50c has been set to a language you don't understand (on a rented back, for example), you can navigate to your preferred language by following the actions and appearance in the illustrations here.

1. Press **MENU**.
2. Navigate to **Settings** ❶ (the fifth menu entry from the top).
3. Navigate to **User Interface** ❷ (the first menu entry).
4. Navigate to **Language** ❸ (the first menu entry).
5. Press the **ZOOM** button ❹ to step through options until you see your preferred language.
6. Save the chosen selection by pressing **EXIT (MENU button)**.



■ TECHNICAL SPECIFICATIONS — CFV 50c

Sensor type	CMOS, 50 Mpixels (8272 × 6200 pixels)
Sensor dimensions	43.8 × 32.9 mm
Pixel size	5.3 × 5.3 μm
Image size	RAW 3FR capture 65 MB on average. TIFF 8 bit: 154 MB
RAW file format	Lossless compressed Hasselblad 3FR
JPEG	1/4 resolution print ready files
Shooting mode	Single shot
Color definition	16 bit
ISO speed range	ISO 100, 200, 400, 800, 1600, 3200 and 6400
Longest exposure time	34 minutes
Color management	Hasselblad Natural Color Solution
CF storage capacity	16 GB CF card holds 240 images on average
Storage options	CF card type U-DMA (e.g. SanDisk Extreme Pro) or tethered to Mac or PC
Acoustic feedback	Yes
Software	Phocus for Mac and Windows (included). Adobe Photoshop Lightroom® (included).
Tethered operation	Supported in Phocus by Hasselblad and Hasselblad Tethered plug-in for Adobe® Photoshop® Lightroom®
Platform support	Macintosh: OS x10.5 or later. Windows: XP, Vista, Windows 7 (from version 2.8, 64 bit only), Windows 8
Host connection type	FireWire 800 (IEEE 1394b). Thunderbolt supported via optional adapters.
View camera compatibility	Mechanical shutters controlled via flash sync, electronic shutters controlled by Phocus.
Power supply	Rechargeable Li-ion battery 8.4 VDC
Operating temperature	0 - 45 deg. C / 32 - 113 deg F
Dimension (WxHxD)	91 × 92 × 57 mm
Weight	530 g without battery
Camera support	All Hasselblad V System cameras manufactured since 1957. 2000 cameras and 201F with C lenses only. 202FA / 203FE and 205FCC camera types need a minor camera modification to use F/FE lenses. The ArcBody is not compatible. SWC/M and newer can be used but has limitations on image quality due to lens design not being suitable for digital capture. All other cameras with Hasselblad V interface.

■ DEFAULT SETTINGS

Quality	RAW
Language	English
Sound volume	High
Exposure warning	On
P button	Instant focus confirm
Display off	30 sec
Power off	30 minutes
Image orientation	Auto
Aspect Ratio	Full
Show preview	On
Animation	On
Tethered power	From host

EQUIPMENT CARE & SERVICE

EQUIPMENT CARE

Hasselblad equipment is designed to withstand the rigors of professional use in most environments. To avoid the possibility of damage however, it should be protected from harsh conditions and in particular avoid oil fumes, steam, humid conditions and dust.

Extremes of temperature: High temperatures can have an adverse effect equipment. Avoid frequent and severe temperature changes and be particularly careful in humid environments. If entering damp or humid conditions from dry and cold conditions, seal all equipment in a plastic bag or similar first before entering and then wait until the equipment has acclimatized to the new temperature before removing. Failure to do so can cause condensation internally as well as externally which can lead to problems particularly in regard to the CFV 50c. Try to ensure the environment or conditions are as dry as possible when storing.

Dust and grit: Take care to prevent dust and grit from getting into your equipment. In coastal areas take measures to protect your equipment from sand and salt water spray. **Impact:** Your equipment can be damaged by severe physical shocks so practical protective precautions should be taken. Some form of protective case or camera bag is advised for transportation.

Loss: Hasselblad equipment is much sought after and you should take obvious steps to prevent theft. Never leave it visible in an unattended car, for example. Separate and specific camera insurance cover should be considered by professional users.

SERVICE

Return your equipment to a service centre for occasional checking and preventive maintenance to ensure optimal reliability. You can easily keep a check on service intervals by looking under 'Info' in the menu. If your equipment is used constantly and intensively, regular periodic check-ups are recommended at one of the **Hasselblad Authorized Service Centers**. They have the expert staff and specialised equipment necessary to ensure that your equipment remains in perfect working order.

CAUTION

- Keep all equipment and accessories out of the reach of small children.
- Do not place heavy objects on the equipment.
- Do not use the batteries except as specified.
- Use only the batteries specified for use.
- Remove the batteries when cleaning the equipment or if you intend to leave the equipment unused for a long period.
- Take particular care when working with strobe / studio flash units to prevent damage to equipment and personal injury.
- Do not attempt to open the CFV 50c.
- Keep the CFV 50c and all other computer equipment away from moisture. If the CFV 50c becomes wet, disconnect from power and allow it to dry before attempting to operate again.
- Always replace the protective sensor/filter cover when the CFV 50c is not connected to the camera.
- Never try to remove the glass IR filter from the front of the sensor as this will probably ruin it. If dust manages to get between the sensor and the IR filter, please contact your Hasselblad dealer for assistance.



Disposal of Waste Equipment by Users in Private Households in the European Union

■ This symbol on the product or on its packaging indicates that this product must not be disposed of with your other household waste. Instead, it is your responsibility to dispose of your waste equipment by handing it over to a designated collection point for the recycling of waste electrical and electronic equipment. The separate collection and recycling of your waste equipment at the time of disposal will help to conserve natural resources and ensure that it is recycled in a manner that protects human health and the environment. For more information about where you can dispose of your waste equipment for recycling, please contact your local city office, your household waste disposal service or the retailer where you purchased the product.

ALPHABETICAL INDEX

CFV 50c

About	28	Hasselblad capture files	7
Appendix	42	Image orientation	26
Aspect ratio	26	Initial settings	17
Battery life & battery warning	43	ISO setting	18
Battery	11	Language	24, 44
Browsing	29	Live View	33
Buttons, parts & components	10	Mark overexposure	26
Camera connectivity	34	Menu	15
Capture destination	7	Navigating the menu	13
CF Cards	12	On/Off button	11
Cleaning	43	P Button	25
Computer system requirements	5	Phocus	8
Custom Options	25	Power off	26
Date & time	24	Powering the CFV 50c	11
Delete	21	Preview	29
Display	25	Quality	19
Equipment care & service	46	Service	27
Exposure time	19	Sound	24
File storage	20	Technical specifications	45
Firmware updates	5	Temperature warning	43
Flash/Strobe	39	Warnings and restrictions	5
Folder	21	White balance setting	18
Format	22	Workflow	7
		Zooming	32

The information in this manual is furnished for informational use only, is subject to change without notice, and should not be construed as a commitment by Victor Hasselblad AB.

The text in this manual cannot be reprinted or reused without the express permission of Victor Hasselblad AB.

The images in this manual cannot be reprinted or reused without the express permission of the photographers who took them.

All text in this manual : © Victor Hasselblad AB.

All images in this manual not credited to a specific photographer:
© Victor Hasselblad AB.

Victor Hasselblad AB assumes no responsibility or liability for any errors or inaccuracies that may appear in this manual.

Victor Hasselblad AB assumes no responsibility or liability for loss or damage incurred during or as a result of using Hasselblad software or products.

Hasselblad, Phocus, Phocus Mobile and Phocus Quick are trademarks of Victor Hasselblad AB. Adobe and Adobe Photoshop are trademarks of Adobe Systems, Inc. Macintosh, Mac OS, iPhone®, iPad® and iPod Touch® and FireWire are registered trademarks of Apple Computer, Inc. InfoLithium is a registered trademark of Sony Corporation. Canon, Nikon, Leica, Sony, Fuji and Olympus are trademarks of their respective corporations. Qp Card is a trademark of Qp Card AB. E-Wipe is a trademark of Photosol Inc.

Copyright © 2014

Victor Hasselblad AB

All rights reserved.

